

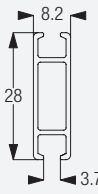







Room Divider/Cubicle/ Shower Rail Systems



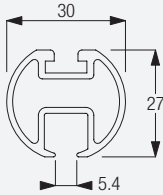

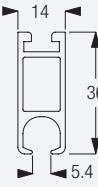
Application Chart

Specification	Profile		Features / Options		Fitting Options			Fitting Surfaces			System		
	Profile Number	Dimensions in mm	Gliding Channel (mm)	Standard Bending Radius (mm)	Safety Device Option	Shower Rail only	Ceiling Fix	Wall Fix	Fitting with Hanger Rods	Wood		Concrete	Suspended ceiling
 kg	1085		3.7	200	●		●	●		●	●	●	1085
 kg	6101		5.4	200			●	●	●	●	●	●	6100
 kg	6103		5.4	300			●	●	●	●	●	●	6103
 kg	6101		5.4	300	●		●	●		●	●	●	6650

 Profile 6109 is available as an alternative profile option for System 6100. This profile is reversible for use as shower rails or uplighter systems (available through Distributors). Standard lengths: 4.75m, 5.25m, 6.0m and 7.5m.

 kg Light-weight applications

 kg Medium-weight applications

 kg Heavy-duty applications

Standard shapes and sizes as shower rail (1085/6100 and 6103 Systems)

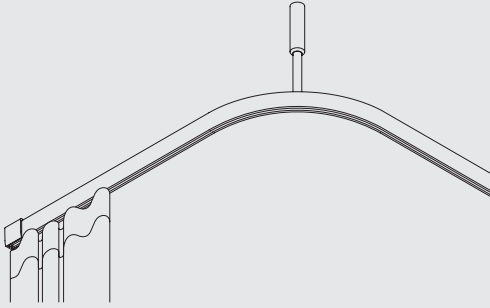

6100/6103 can also be custom shaped for special baths.
Both are available in silver anodised finish.
6103 is also available in chrome and anodised gold finished.

Model A

91cm, 183cm, 213cm, 244cm



Model B

76cm x 76cm, 91cm x 91cm

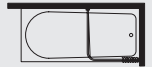

Model C/D

168cm x 76cm (Reversible rail 6109)

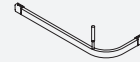

Model E

91cm x 76cm x 91cm

